



Ramp It Up VAV Ramps and Controller Possibilities

The following article explains the various VAV ramps available on our products. Not all controllers come with the same options. Refer to the Specification and Installation Instructions of each controller for appropriate information.

The first section concerns motor ramps, which are the type of action taken by the damper actuator of the VAV box. The second section covers the duct reheat, baseboard and sub-cool sequence of operation. The third section shows the possibilities and limitations of each controller able to control a VAV box.

Motor Ramps

Cooling Only – The central system can only deliver cool air to the VAV box. All the heat will come from the reheat and baseboard.

Cooling Only Application

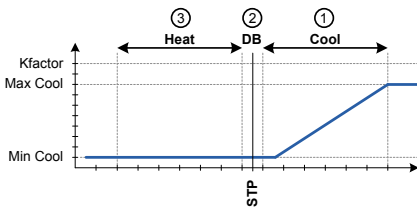

- ① When the zone is calling for cool, the cooling loop output is mapped to the airflow setpoint from the cooling minimum to cooling maximum airflow setpoints.
- ② When the zone is in the dead band mode, the airflow setpoint shall be the cooling minimum airflow setpoint.
- ③ When the zone is calling for heat, the airflow setpoint shall be the cooling minimum airflow setpoint.

Heating Only – The central system can only deliver hot air to the VAV box.

Heating Only Application

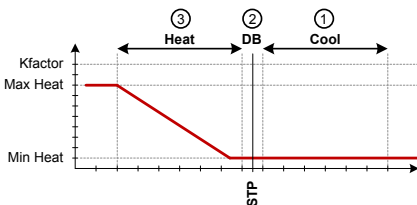

- ① When the zone is calling for cool, the airflow setpoint shall be the heating minimum airflow setpoint.
- ② When the zone is in the dead band mode, the airflow setpoint shall be the heating minimum airflow setpoint.
- ③ When the zone is calling for heat, the heating loop output is mapped to the airflow setpoint from the heating minimum to heating maximum airflow setpoints.

Cooling & Heating (Changeover) – The central system can deliver cool and hot air to the VAV box. A changeover sensor/switch is required.

Changeover (Cooling & Heating) Application

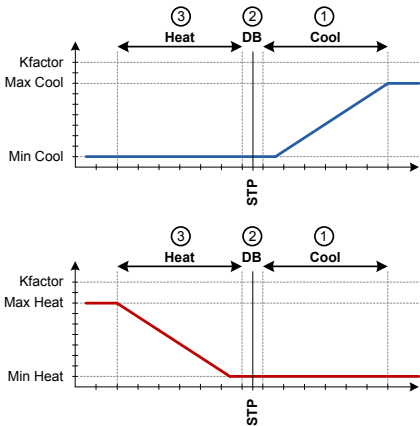

Sequence of Operation - System in Cooling

- ① When the zone is calling for cool, the cooling loop output is mapped to the airflow setpoint from the cooling minimum to cooling maximum airflow setpoints.
- ② When the zone is in the dead band mode, the airflow setpoint shall be the cooling minimum airflow setpoint.
- ③ When the zone is calling for heat, the airflow setpoint shall be the cooling minimum airflow setpoint.

Sequence of Operation - System in Heating

- ① When the zone is calling for cool, the airflow setpoint shall be the heating minimum airflow setpoint.
- ② When the zone is in the dead band mode, the airflow setpoint shall be the heating minimum airflow setpoint.
- ③ When the zone is calling for heat, the heating loop output is mapped to the airflow setpoint from the heating minimum to heating maximum airflow setpoints.

CH1 – The central system can only deliver cool air to the VAV box. When there is a demand for heat, the controller uses the maximum and minimum heating airflow setpoints and activates reheat. This ramp is only supported by the EVCB series.

CH1 (4 airflow setpoints) Application

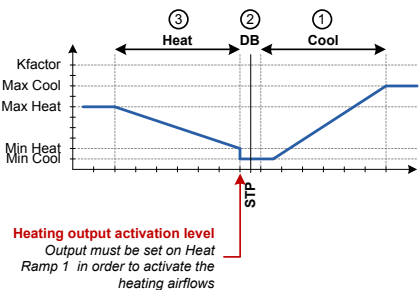

- ① When the zone is calling for cool, the cooling loop output is mapped to the airflow setpoint from the cooling minimum to cooling maximum airflow setpoints.
- ② When the zone is in the dead band mode, the airflow setpoint shall be the cooling minimum airflow setpoint.
- ③ When the zone is calling for heat, the heating loop output is mapped to the airflow setpoint from the heating minimum to heating maximum airflow setpoints. This sequence can only operate if an output is configured in heating.

Note that the EVCB series controllers can also be configured as CAV (Constant Air Volume).

Cooling and Heating Ramps

Reheat refers to the heating device located after the VAV box. It can either be a water coil or it can be electric. Signals vary based on the type of heater. The supported signals are:

On/Off or 1 Stage Heating

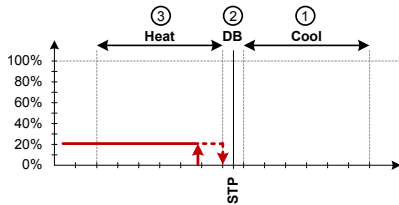

- ① When the zone is calling for cool, the heating outputs are disabled.
- ② When the zone is in the dead band mode, the heating outputs are disabled.
- ③ When the zone is calling for heat, the heating output is energized to maintain zone setpoint.

2 Stage Heating

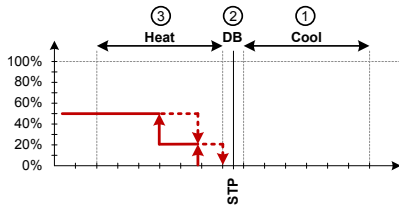

- ① When the zone is calling for cool, the heating outputs are disabled.
- ② When the zone is in the dead band mode, the heating outputs are disabled.
- ③ When the zone is calling for heat, the heating output is energized to maintain zone setpoint. If temperature continues to drop, the second heating stage is energized.

3 Stage Heating

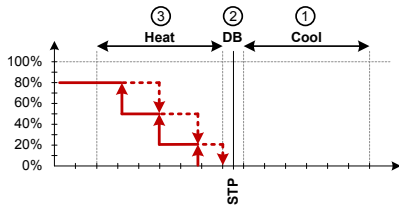

- ① When the zone is calling for cool, the heating outputs are disabled.
- ② When the zone is in the dead band mode, the heating outputs are disabled.
- ③ When the zone is calling for heat, the heating output is energized to maintain zone setpoint. If temperature continues to drop, the second and third heating stages are energized according to the heating demand.

www.neptronic.com

4 Stage Heating

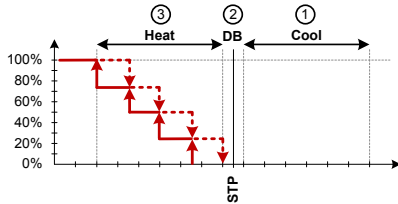

- ① When the zone is calling for cool, the heating outputs are disabled.
- ② When the zone is in the dead band mode, the heating outputs are disabled.
- ③ When the zone is calling for heat, the heating output is energized to maintain zone setpoint. If temperature continues to drop, the second, third and fourth heating stages are energized according to the heating demand.

Modulating, Pulse and/or Floating

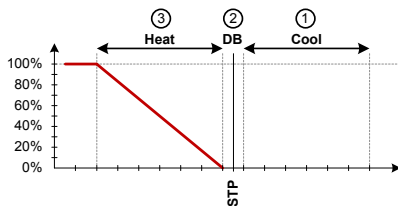

- ① When the zone is calling for cool, the heating outputs are disabled.
- ② When the zone is in the dead band mode, the heating outputs are disabled.
- ③ When the zone is calling for heat, the heating output modulates to maintain zone setpoint.

Note that the cooling ramps can be in the same format as the heating ramps, except for pulse signals (heating only).

Baseboard refers to the heating devices located on the exterior walls of a building. They are used to maintain temperature for external zones and are great to cut the cold drafts generated by the windows in winter time. Baseboards can be supplied by hot water or they can be electric. The signals supported are the same as the reheat (except for stages).

Note that the reheat and baseboards can be activated at the same time or offset from one another. Some prefer setting the baseboards as a first stage and other prefer the reheat as the first stage.

Sub-cool refers to the cooling devices located after the VAV box. In terminal unit applications, these are water coils, but DX coils are possible. We do not have many requests for this type of control, but it is available. The supported signals are:

- On/Off or 1 Stage (water and DX)
- 2 Stages (DX only)
- 3 Stages (DX only)
- 4 Stages (DX only)

www.neptronic.com

- Modulating 0-10Vdc & 2-10Vdc which includes 0-20mA & 4-20mA with a 500Ω resistance (water only)
- Floating (water only)

Possible configurations based on the controller model for single duct applications

Controller models are identified on the top of the page.

Application drawing shows the possible configurations and required input/output(s).

The controller at the bottom of the page represents the input/output point count and configurations supported.

www.neptronic.com

TRO5404 - VAV Single Duct

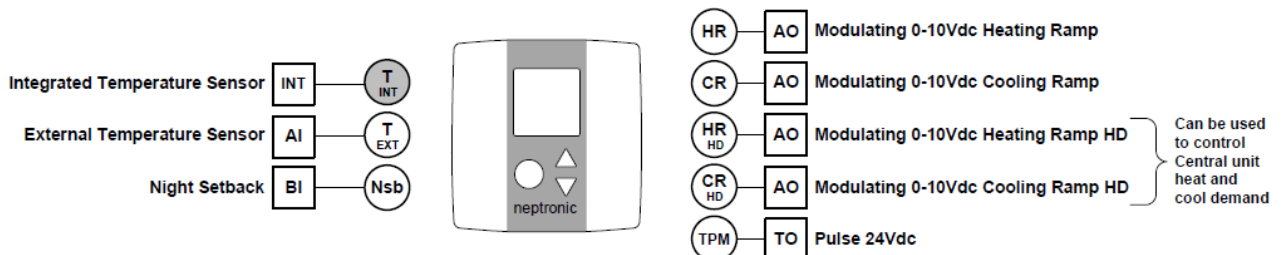
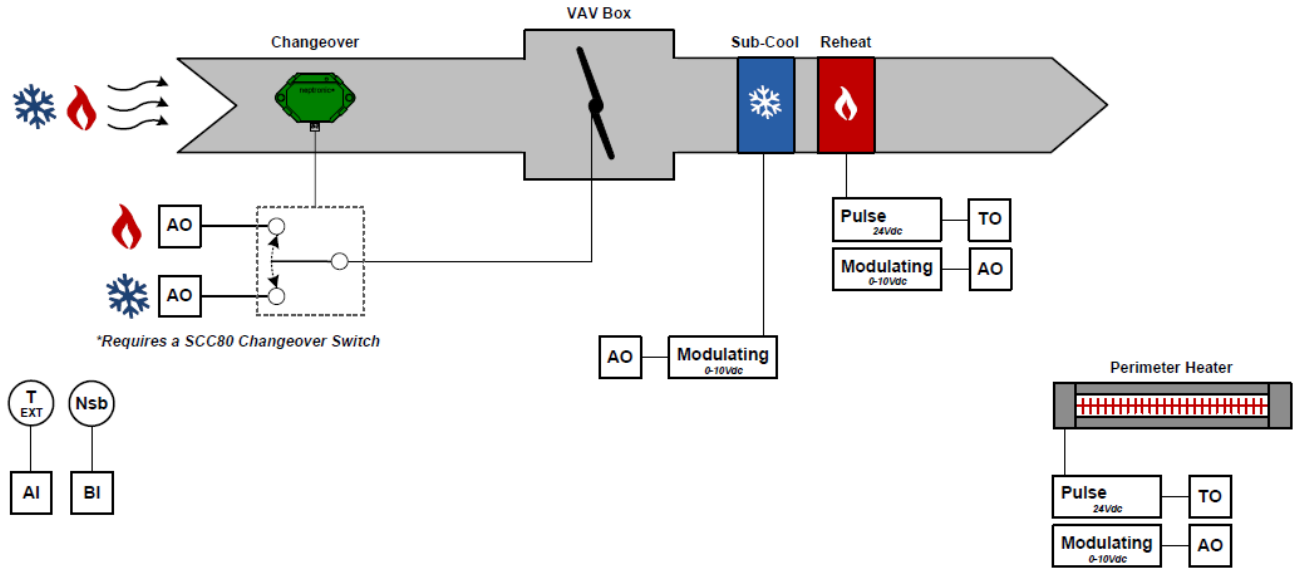

www.neptronic.com

TRO54P3X1 - VAV Single Duct

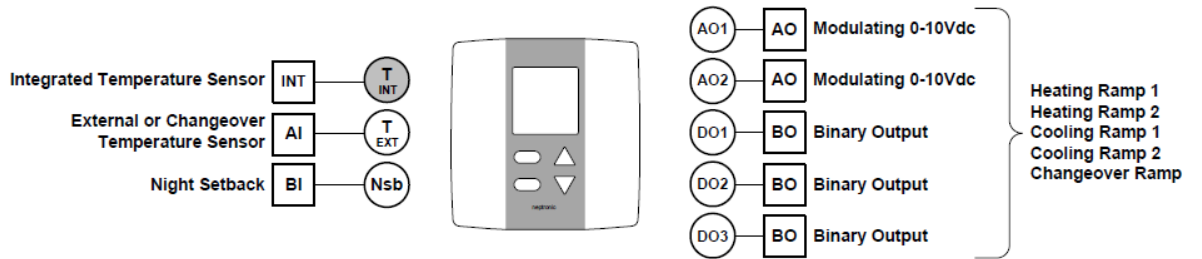
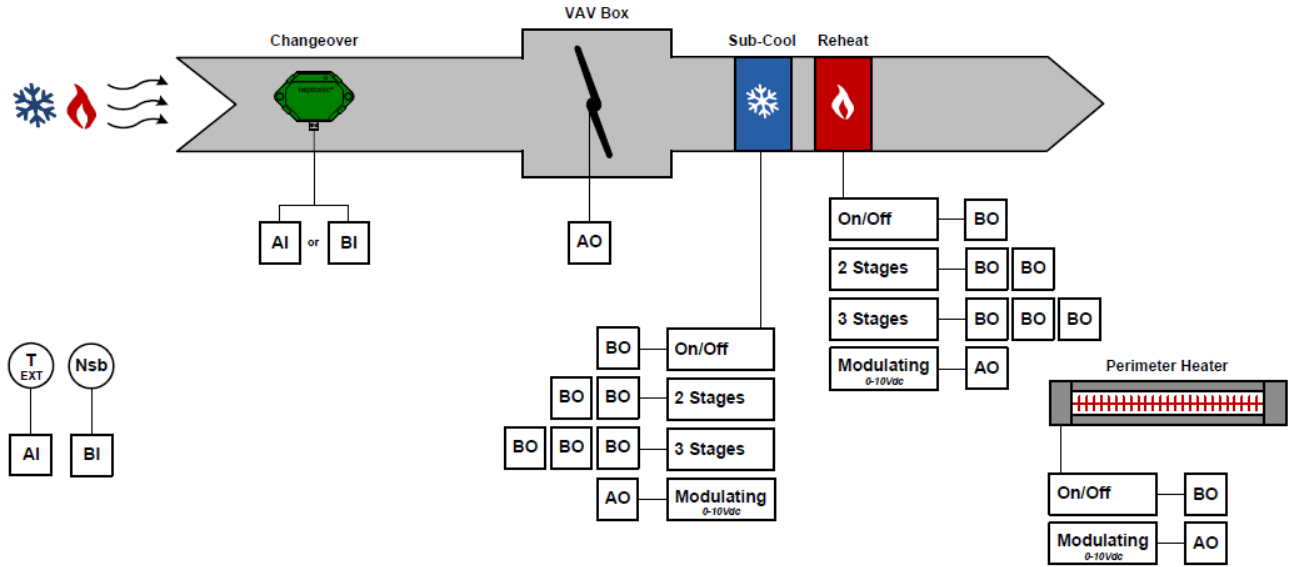

www.neptronic.com

TRO24 Series - VAV Single Duct

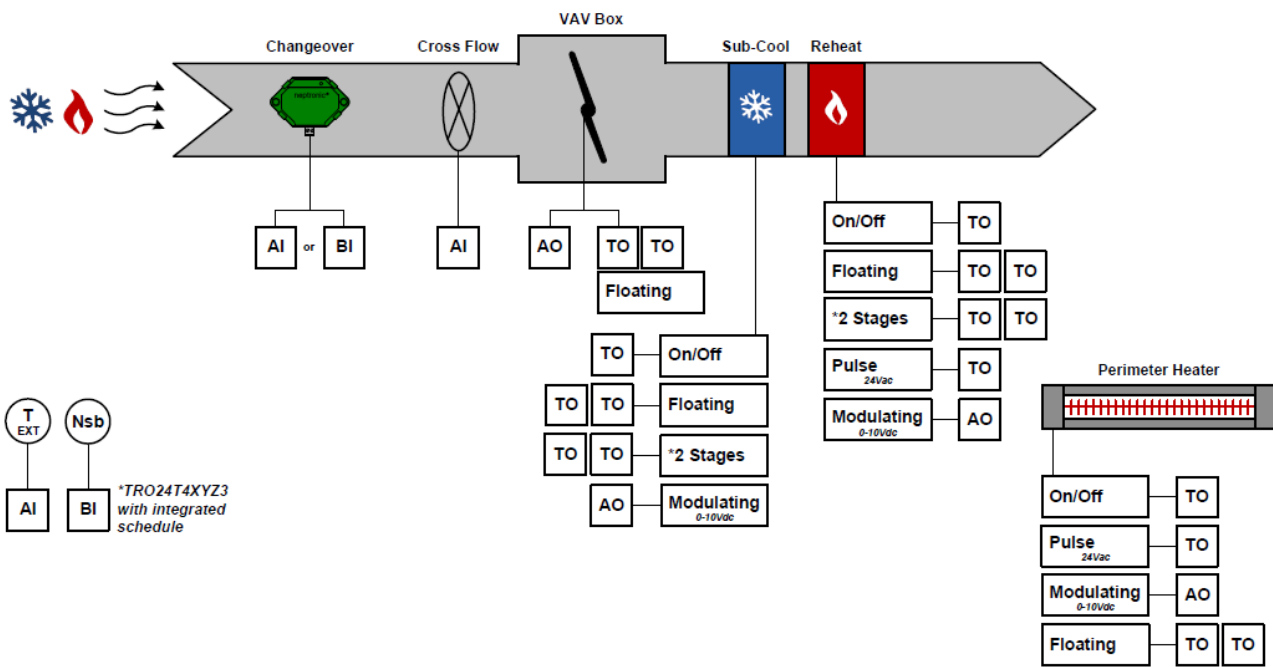

Note: Outputs can be configured as Reverse Acting

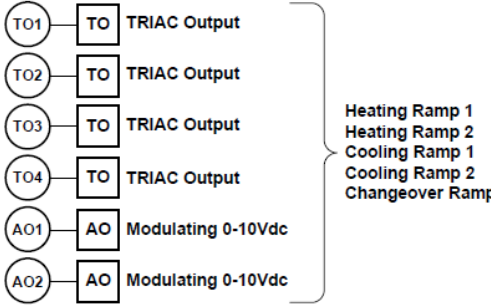
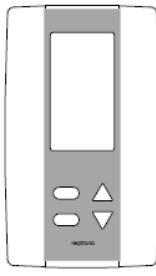
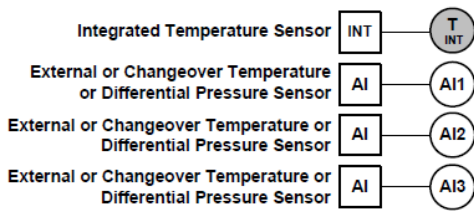

EVC Series - VAV Single Duct Excluding EVCB14NIT4X

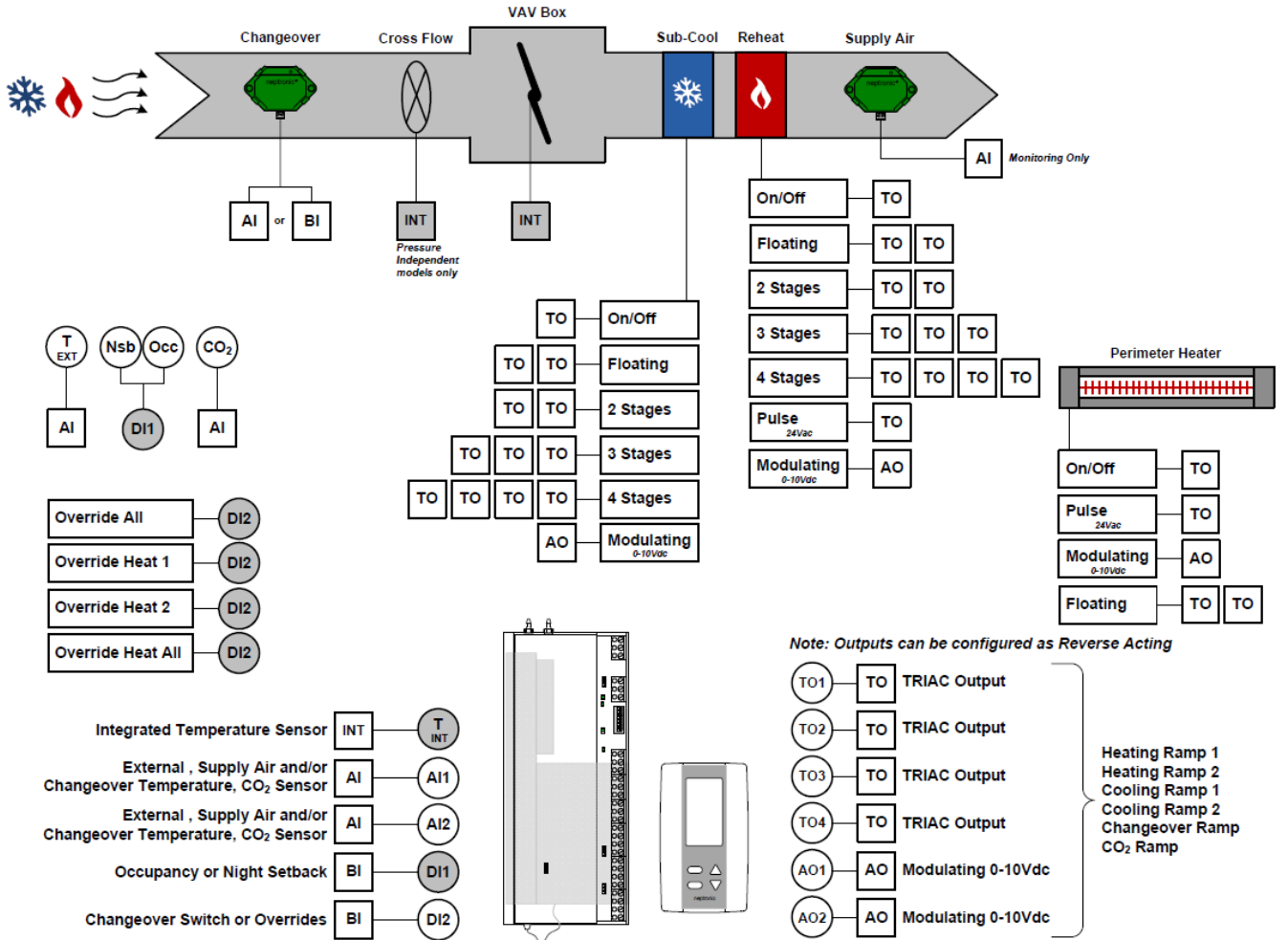

www.neptronic.com

HVAC Controls
 Electric Actuators
 Actuated Valves
 Humidifiers
 Electric Heaters

EVCB14NIT4X - VAV Single Duct

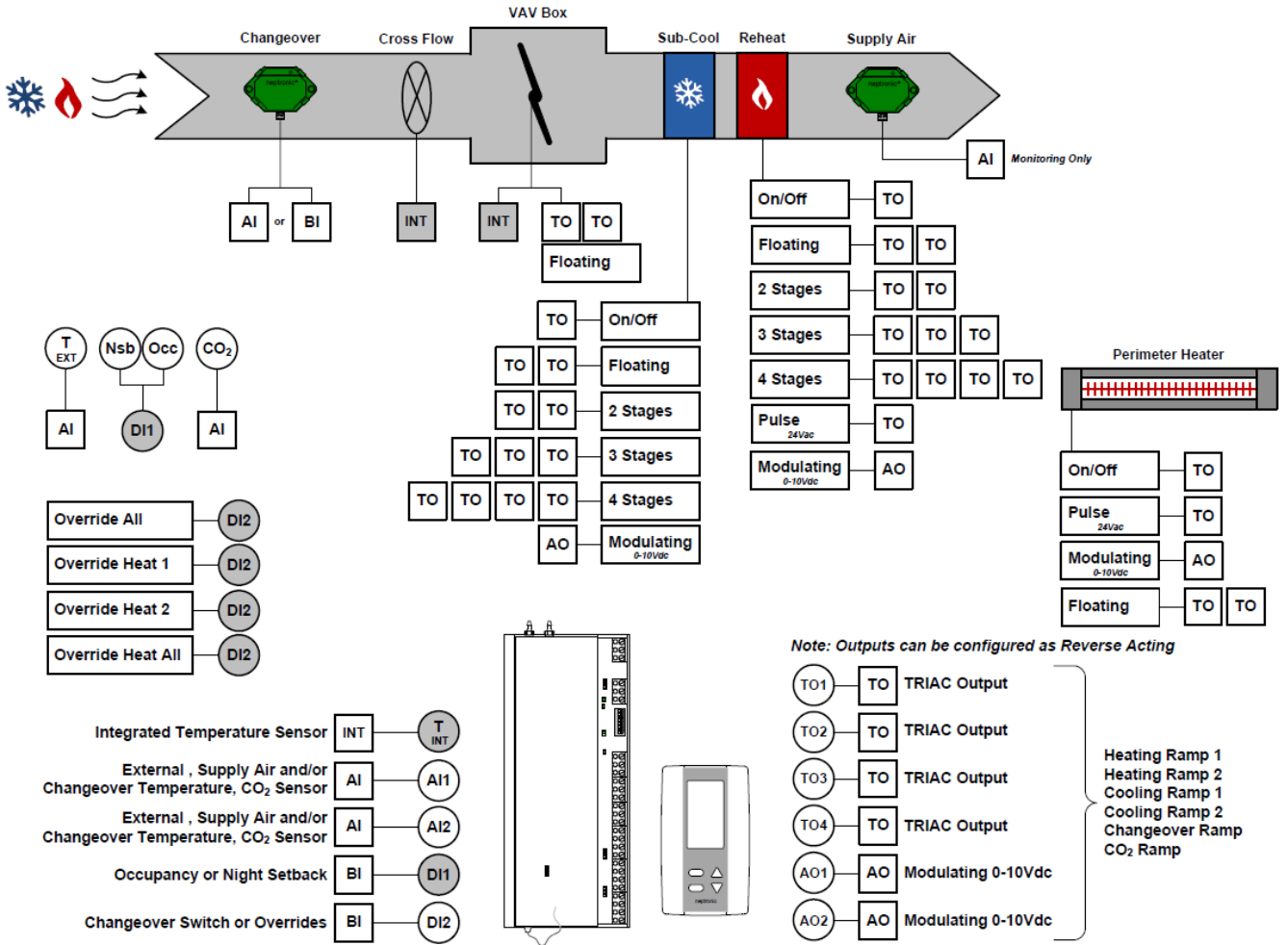

www.neptronic.com